

Pérgolas Bioclimáticas



BIOCLIMÁTICA

Bio ORIGEN

Top lamas oscilobatientes.



LIMITACIONES DE USO

Pérgola **BIO** *ORIGEN*

- Estructura horizontal
- Superficie hasta 12 m²/li>
- Ajuste de la intensidad solar parcial o total,
- Apertura de las lamas a 90°
- Maniobra manual TA1/09
- Instalación rápida y fácil de las pies y de las lamas
- Pies de 95×95 mm

Salida/proyección:

3,99 m.

Ancho :

3.50 m máx.

Altura :

2,30m máx.

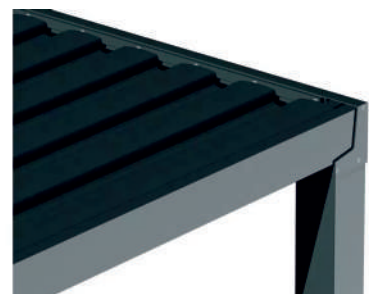
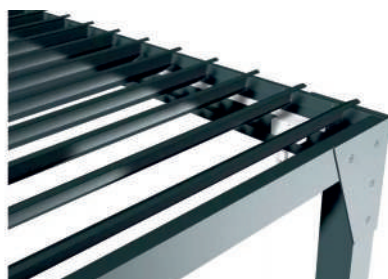



CARACTERÍSTICAS ESTABLECIDAS: PARALELA E ISLA
1 modulo UNICAMENTE

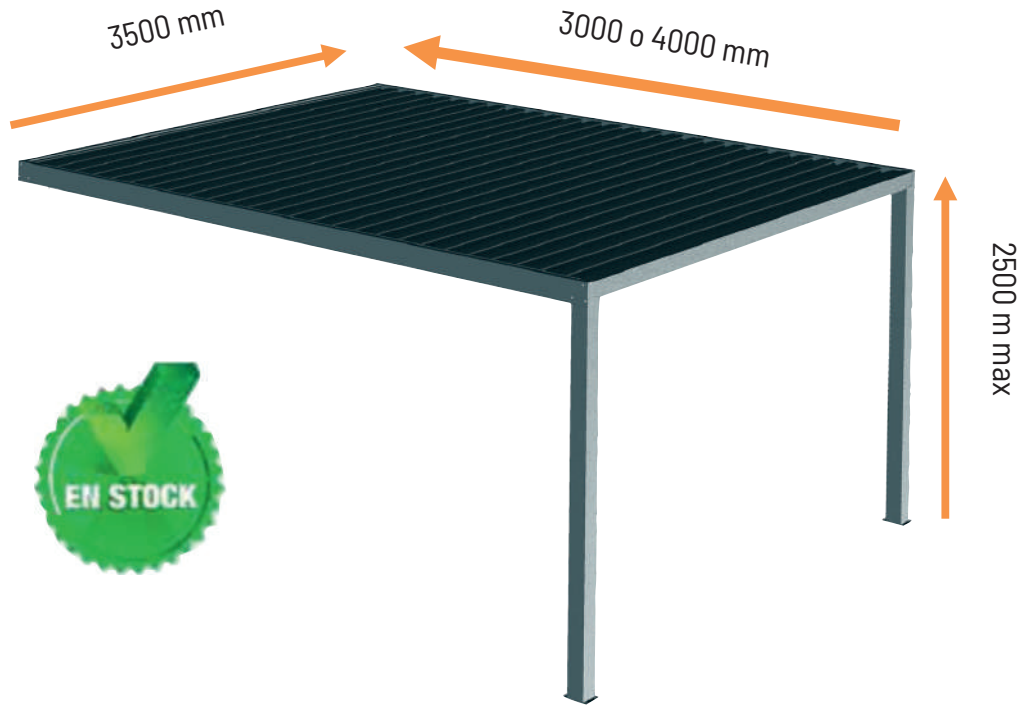

Apertura Manual



Cambiador Cilindro

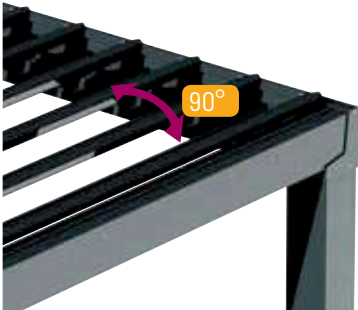

Pérgola BIO
ORIGEN

VENTAJAS DEL PRODUCTO

- Entrega mas rápida
- ~~nuevo~~ Diseño
- Lamas simples
- Superficie 10,5m² (3,5 x 3 m) o 14m² (3,5 x 4 m)
- Pérgola bioclimáticas con máquina y manivela
- Sistema de iluminación LED opcional
- Opción con toldos laterales
- Protección lateral

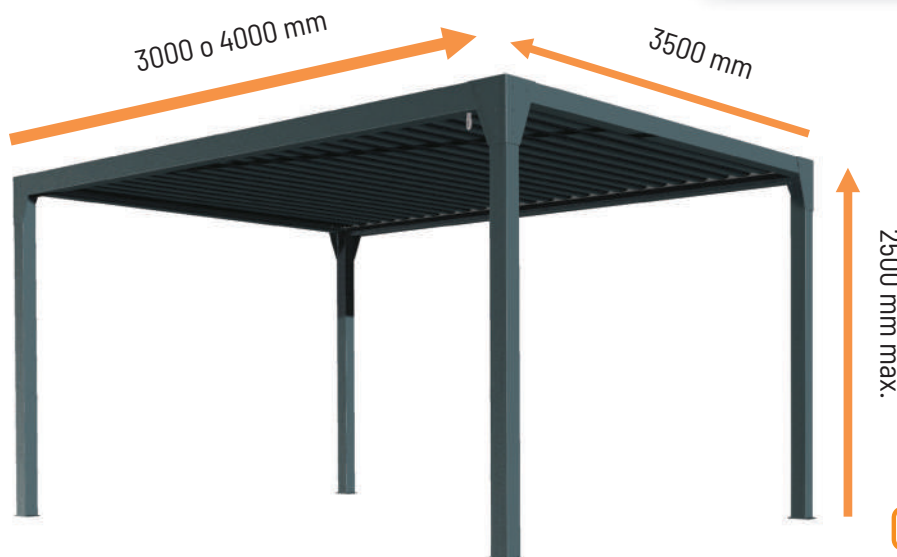

Pergola BIO ORIGEN

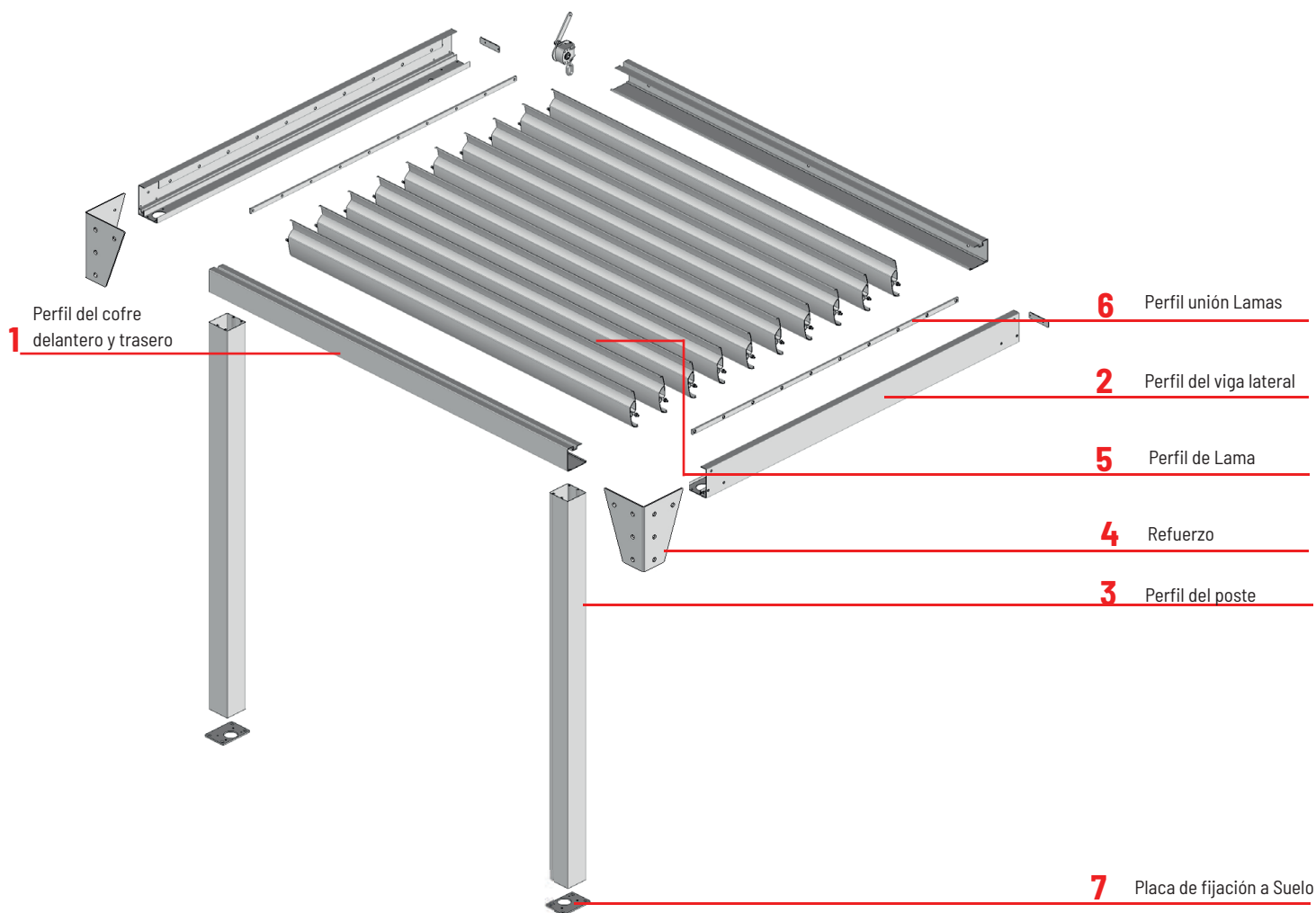

Soporte de fijación al suelo: ST45

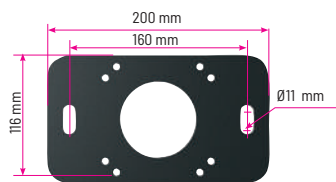

Lacados estándar



Posibilidad de lacado mixto:
Estructura COLOR / Lamas BLANCO

Opción Mototizada



central de radio
para remoto

AUTOMOPRO3
+ TELEPRO01

WhatsApp



625 61 92 36



610 18 59 38

Fábrica - Exposición:

Polígono de Rocas IV • C/. Arquímedes, 867
33211 GIJÓN. Asturias. España
☎ 985 16 87 62

Oficina ShowRoom:

Av. de la Técnica 73, Nave 69
28522, (Rivas-Vaciamadrid) MADRID. España

GRUPO **diseña**
SOLUCIONES
cerramientosporches.com